

SISTEMA DE MONTAJE DE 10 PANELES INCLINADO 15 - 30°
PARA PANELES DE HASTA 1160MM DE ANCHO
CON RIELES DE 4.2M Y 4.8M

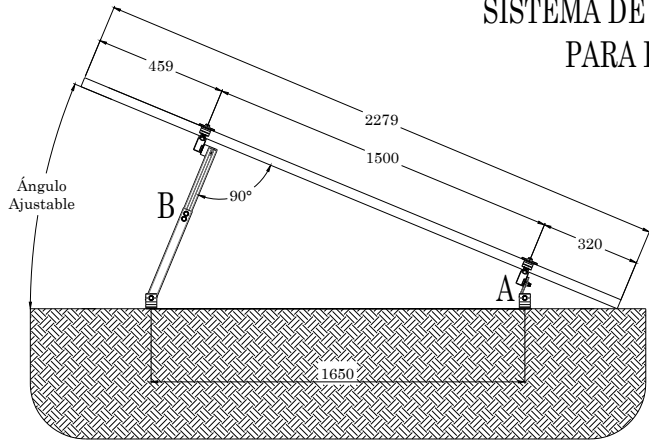

VISTA LATERAL

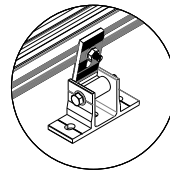

DETALLE A
Soporte Frontal
Ajustable

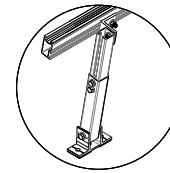

DETALLE B
Soporte Trasero
Ajustable

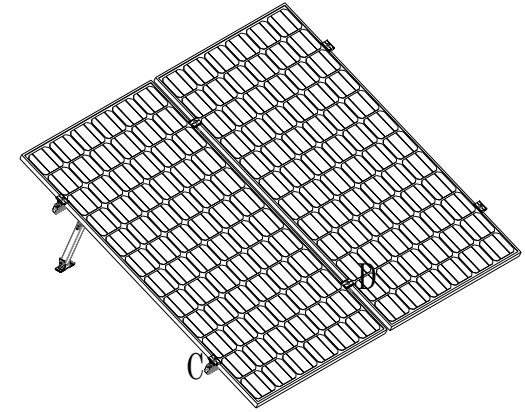

VISTA ISOMÉTRICA

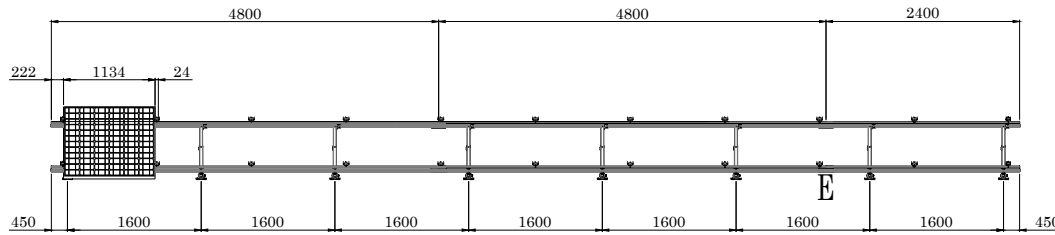

VISTA FRONTAL

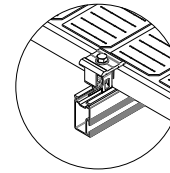

DETALLE C
Abrazadera
Universal
(Modo Remate)

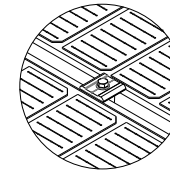

DETALLE D
Abrazadera
Universal
(Modo Intermedio)

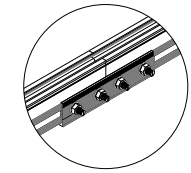

DETALLE E
Empalme de Riel

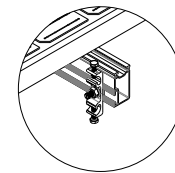

Terminal de
Conexión a Tierra

NOTA: 1 NXT-R-4800-MILL se corta a la mitad

# Parte	Descripción	Cantidad
NXT-R-4200-MILL	Perfil NextRail 4.2m, mill finish, Aluminio 6105-T6	0
NXT-R-4800-MILL	Perfil NextRail 4.8m, mill finish, Aluminio 6105-T6	5
NXT-ER-2	2 Empalmes de riel con puesta a tierra, para Next-Rail	2
NXT-AUT-30/46-2	2 Abrazadera universal p/panel con marco de 30-46mm	11
NXT-TCT-1	1 Terminal de conexión a tierra para Next-Rail	1
NXT-CLIP-5	5 Clips de plástico para dos cables, Next-Rail	5
NXT-SFA-1	1 Soporte frontal ajustable para Next-Rail	8
NXT-STA-15/30-1	1 Soporte trasero ajustable 15-30° para Next-Rail	8

observaciones		 	
MATERIAL:		N° DE DIBUJO	A3
FECHA	05/12/2021	NXT-SMI10-30-1160	
ACOT.	mm [in]		
PESO:	31.121 kg	ESCALA: NA	H01A1 DE 1